

LM3046 Transistor Array

General Description

The LM3046 consists of five general purpose silicon NPN transistors on a common monolithic substrate. Two of the transistors are internally connected to form a differentially-connected pair. The transistors are well suited to a wide variety of applications in low power system in the DC through VHF range. They may be used as discrete transistors in conventional circuits however, in addition, they provide the very significant inherent integrated circuit advantages of close electrical and thermal matching. The LM3046 is supplied in a 14-lead molded small outline package.

Features

- Two matched pairs of transistors
 V_{BE} matched ± 5 mV
 Input offset current $2 \mu\text{A}$ max at $I_C = 1$ mA
- Five general purpose monolithic transistors
- Operation from DC to 120 MHz
- Wide operating current range
- Low noise figure: 3.2 dB typ at 1 kHz

Applications

- General use in all types of signal processing systems operating anywhere in the frequency range from DC to VHF
- Custom designed differential amplifiers
- Temperature compensated amplifiers

Schematic and Connection Diagram

Small Outline Package

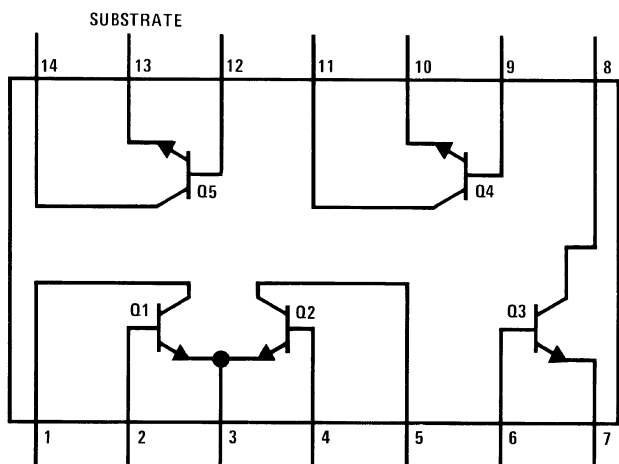

00795001

Top View
 Order Number LM3046M
 See NS Package Number M14A

Absolute Maximum Ratings (Note 1)

If Military/Aerospace specified devices are required, please contact the National Semiconductor Sales Office/

Distributors for availability and specifications. ($T_A = 25^\circ\text{C}$)

	LM3046		Units
	Each Transistor	Total Package	
Power Dissipation:			
$T_A = 25^\circ\text{C}$	300	750	mW
$T_A = 25^\circ\text{C}$ to 55°C	300	750	mW
$T_A > 55^\circ\text{C}$	Derate at 6.67		mW/ $^\circ\text{C}$
$T_A = 25^\circ\text{C}$ to 75°C			mW
$T_A > 75^\circ\text{C}$			mW/ $^\circ\text{C}$
Collector to Emitter Voltage, V_{CEO}	15		V
Collector to Base Voltage, V_{CBO}	20		V
Collector to Substrate Voltage, V_{CIO} (Note 2)	20		V
Emitter to Base Voltage, V_{EBO}	5		V
Collector Current, I_C	50		mA
Operating Temperature Range	-40°C to $+85^\circ\text{C}$		
Storage Temperature Range	-65°C to $+85^\circ\text{C}$		
Soldering Information			
Dual-In-Line Package Soldering (10 Sec.)	260 $^\circ\text{C}$		
Small Outline Package			
Vapor Phase (60 Seconds)	215 $^\circ\text{C}$		
Infrared (15 Seconds)	220 $^\circ\text{C}$		

See AN-450 "Surface Mounting Methods and Their Effect on Product Reliability" for other methods of soldering surface mount devices.

Electrical Characteristics

($T_A = 25^\circ\text{C}$ unless otherwise specified)

Parameter	Conditions	Limits			Units
		Min	Typ	Max	
Collector to Base Breakdown Voltage ($V_{(BR)CBO}$)	$I_C = 10\ \mu\text{A}$, $I_E = 0$	20	60		V
Collector to Emitter Breakdown Voltage ($V_{(BR)CEO}$)	$I_C = 1\ \text{mA}$, $I_B = 0$	15	24		V
Collector to Substrate Breakdown Voltage ($V_{(BR)CIO}$)	$I_C = 10\ \mu\text{A}$, $I_{CI} = 0$	20	60		V
Emitter to Base Breakdown Voltage ($V_{(BR)EBO}$)	$I_E = 10\ \mu\text{A}$, $I_C = 0$	5	7		V
Collector Cutoff Current (I_{CBO})	$V_{CB} = 10\text{V}$, $I_E = 0$		0.002	40	nA
Collector Cutoff Current (I_{CEO})	$V_{CE} = 10\text{V}$, $I_B = 0$			0.5	μA
Static Forward Current Transfer Ratio (Static Beta) (h_{FE})	$V_{CE} = 3\text{V}$ $I_C = 10\ \text{mA}$ $I_C = 1\ \text{mA}$ $I_C = 10\ \mu\text{A}$		100 40 54		
Input Offset Current for Matched Pair Q_1 and Q_2 $ I_{O1} - I_{O2} $	$V_{CE} = 3\text{V}$, $I_C = 1\ \text{mA}$		0.3	2	μA
Base to Emitter Voltage (V_{BE})	$V_{CE} = 3\text{V}$ $I_E = 1\ \text{mA}$ $I_E = 10\ \text{mA}$		0.715 0.800		V
Magnitude of Input Offset Voltage for Differential Pair $ V_{BE1} - V_{BE2} $	$V_{CE} = 3\text{V}$, $I_C = 1\ \text{mA}$		0.45	5	mV
Magnitude of Input Offset Voltage for Isolated Transistors $ V_{BE3} - V_{BE4} $, $ V_{BE4} - V_{BE5} $, $ V_{BE5} - V_{BE3} $	$V_{CE} = 3\text{V}$, $I_C = 1\ \text{mA}$		0.45	5	mV

Electrical Characteristics (Continued)(T_A = 25°C unless otherwise specified)

Parameter	Conditions	Limits			Units
		Min	Typ	Max	
Temperature Coefficient of Base to Emitter Voltage $\left(\frac{\Delta V_{BE}}{\Delta T}\right)$	V _{CE} = 3V, I _C = 1 mA		-1.9		mV/°C
Collector to Emitter Saturation Voltage (V _{CE(SAT)})	I _B = 1 mA, I _C = 10 mA		0.23		V
Temperature Coefficient of Input Offset Voltage $\left(\frac{\Delta V_{10}}{\Delta T}\right)$	V _{CE} = 3V, I _C = 1 mA		1.1		μV/°C

Note 1: "Absolute Maximum Ratings" indicate limits beyond which damage to the device may occur. Operating Ratings indicate conditions for which the device is functional, but do not guarantee specific performance limits.

Note 2: The collector of each transistor is isolated from the substrate by an integral diode. The substrate (terminal 13) must be connected to the most negative point in the external circuit to maintain isolation between transistors and to provide for normal transistor action.

Electrical Characteristics

Parameter	Conditions	Min	Typ	Max	Units
Low Frequency Noise Figure (NF)	f = 1 kHz, V _{CE} = 3V, I _C = 100 μA, R _S = 1 kΩ		3.25		dB
LOW FREQUENCY, SMALL SIGNAL EQUIVALENT CIRCUIT CHARACTERISTICS					
Forward Current Transfer Ratio (h _{fe})	f = 1 kHz, V _{CE} = 3V, I _C = 1 mA		110		
Short Circuit Input Impedance (h _{ie})			3.5		kΩ
Open Circuit Output Impedance (h _{oe})			15.6		μmho
Open Circuit Reverse Voltage Transfer Ratio (h _{re})			1.8 x 10 ⁻⁴		
ADMITTANCE CHARACTERISTICS					
Forward Transfer Admittance (Y _{fe})	f = 1 MHz, V _{CE} = 3V, I _C = 1 mA		31 - j 1.5		
Input Admittance (Y _{ie})			0.3 + j 0.04		
Output Admittance (Y _{oe})			0.001 + j 0.03		
Reverse Transfer Admittance (Y _{re})			See Curve		
Gain Bandwidth Product (f _T)	V _{CE} = 3V, I _C = 3 mA	300	550		
Emitter to Base Capacitance (C _{EB})	V _{EB} = 3V, I _E = 0		0.6		pF
Collector to Base Capacitance (C _{CB})	V _{CB} = 3V, I _C = 0		0.58		pF
Collector to Substrate Capacitance (C _{Cl})	V _{CS} = 3V, I _C = 0		2.8		pF

Typical Performance Characteristics

Typical Collector To Base Cutoff Current vs Ambient Temperature for Each Transistor

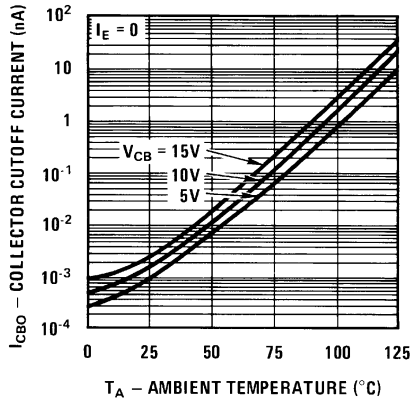

00795008

Typical Collector To Emitter Cutoff Current vs Ambient Temperature for Each Transistor

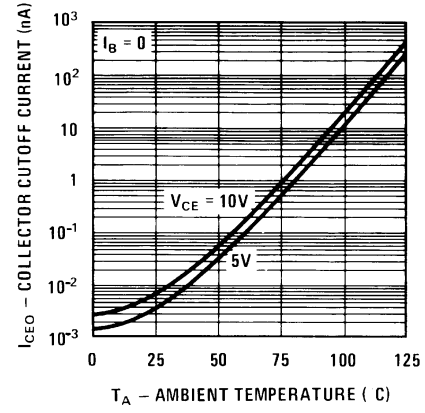

00795009

Typical Static Forward Current-Transfer Ratio and Beta Ratio for Transistors Q_1 and Q_2 vs Emitter Current

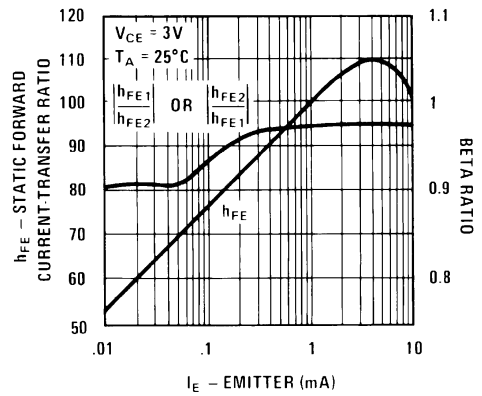

00795010

Typical Input Offset Current for Matched Transistor Pair Q_1 Q_2 vs Collector Current

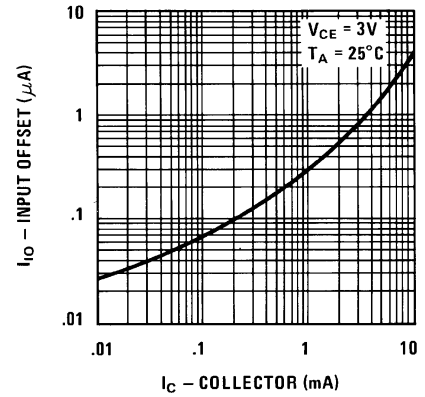

00795011

Typical Static Base To Emitter Voltage Characteristic and Input Offset Voltage for Differential Pair and Paired Isolated Transistors vs Emitter Current

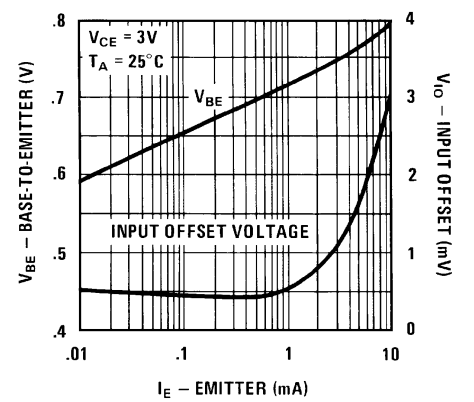

00795012

Typical Base To Emitter Voltage Characteristic for Each Transistor vs Ambient Temperature

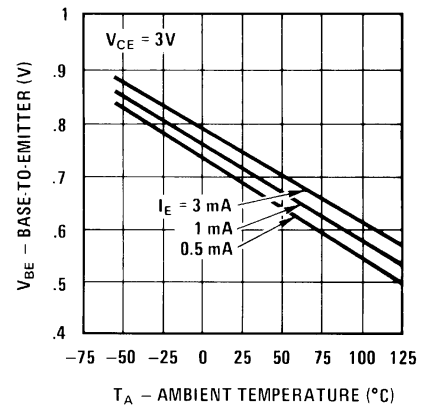

00795013

Typical Performance Characteristics (Continued)

Typical Input Offset Voltage Characteristics for Differential Pair and Paired Isolated Transistors vs Ambient Temperature

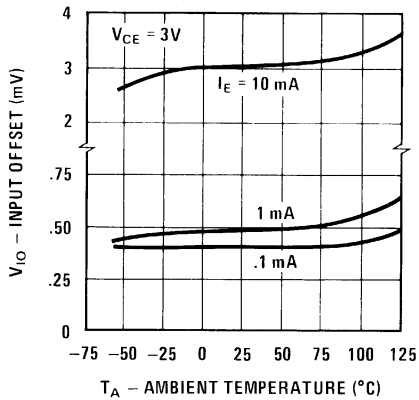

00795014

Typical Noise Figure vs Collector Current

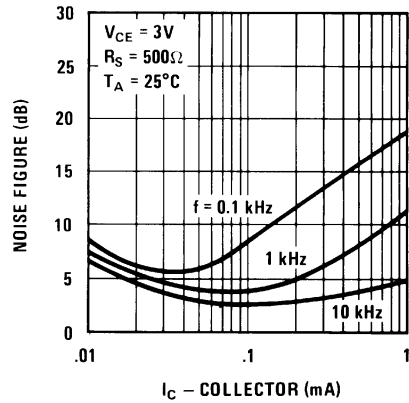

00795015

Typical Noise Figure vs Collector Current

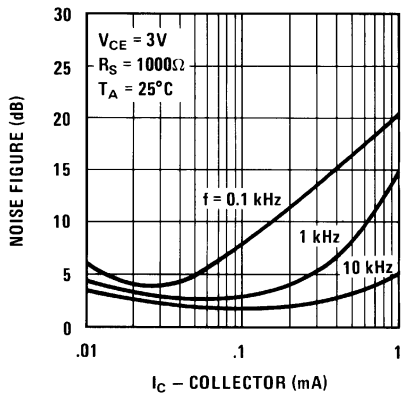

00795016

Typical Noise Figure vs Collector Current

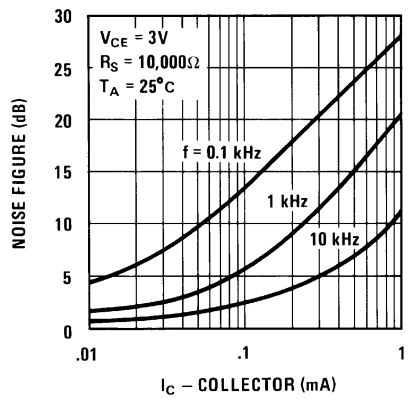

00795017

Typical Performance Characteristics (Continued)

Typical Normalized Forward Current Transfer Ratio, Short Circuit Input Impedance, Open Circuit Output Impedance, and Open Circuit Reverse Voltage Transfer Ratio vs Collector Current

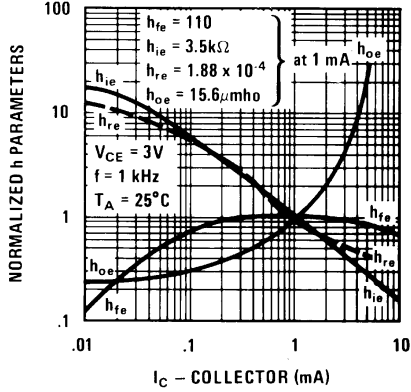

00795018

Typical Forward Transfer Admittance vs Frequency

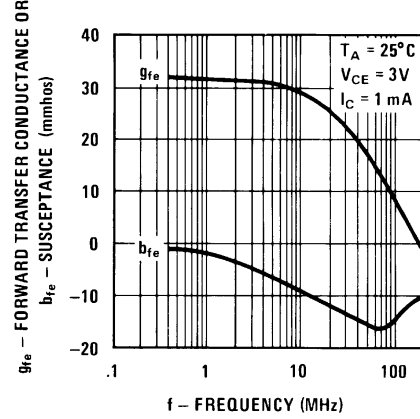

00795019

Typical Input Admittance vs Frequency

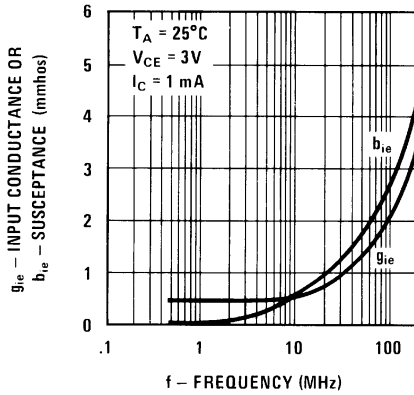

00795020

Typical Output Admittance vs Frequency

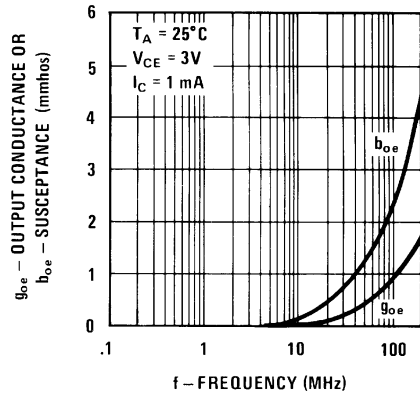

00795021

Typical Reverse Transfer Admittance vs Frequency

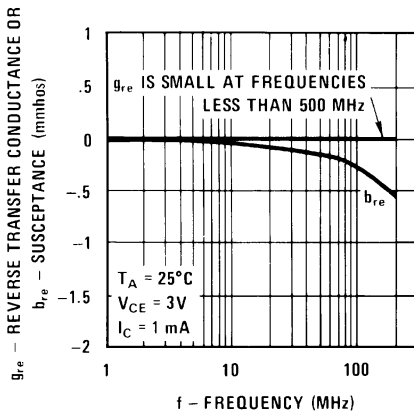

00795022

Typical Gain-Bandwidth Product vs Collector Current

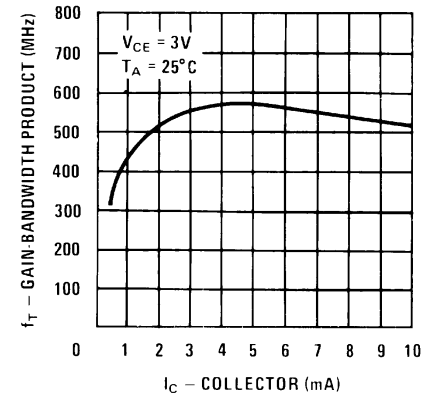

00795023

Physical Dimensions inches (millimeters)

unless otherwise noted

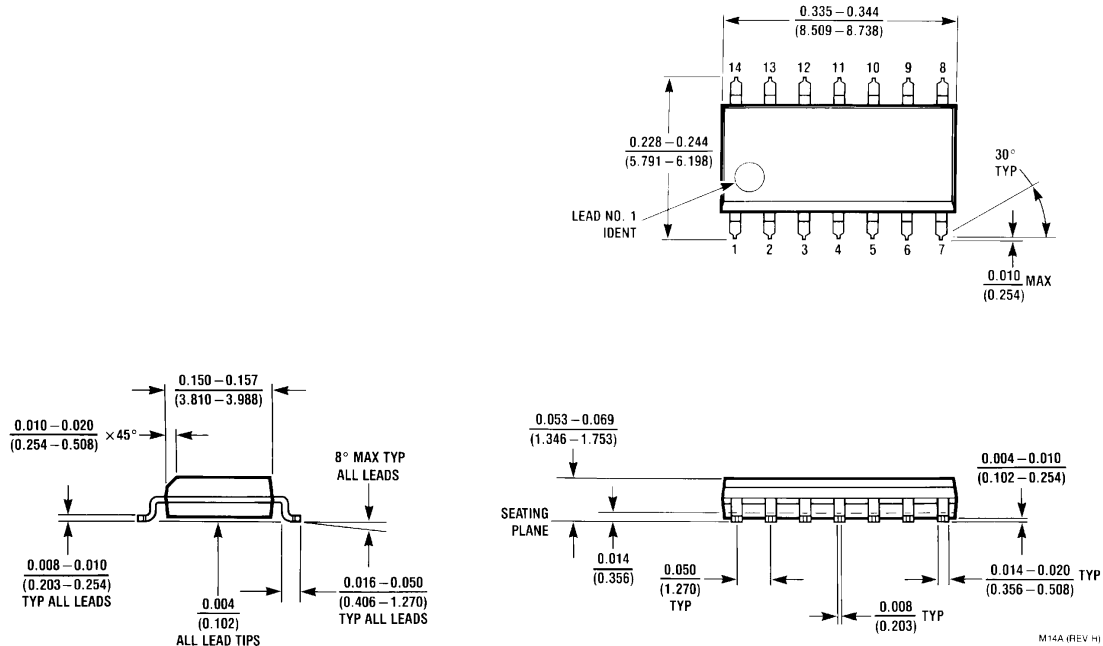

Molded Small Outline Package (M)
Order Number LM3046M
NS Package Number M14A

National does not assume any responsibility for use of any circuitry described, no circuit patent licenses are implied and National reserves the right at any time without notice to change said circuitry and specifications.

For the most current product information visit us at www.national.com.

LIFE SUPPORT POLICY

NATIONAL'S PRODUCTS ARE NOT AUTHORIZED FOR USE AS CRITICAL COMPONENTS IN LIFE SUPPORT DEVICES OR SYSTEMS WITHOUT THE EXPRESS WRITTEN APPROVAL OF THE PRESIDENT AND GENERAL COUNSEL OF NATIONAL SEMICONDUCTOR CORPORATION. As used herein:

- Life support devices or systems are devices or systems which, (a) are intended for surgical implant into the body, or (b) support or sustain life, and whose failure to perform when properly used in accordance with instructions for use provided in the labeling, can be reasonably expected to result in a significant injury to the user.
- A critical component is any component of a life support device or system whose failure to perform can be reasonably expected to cause the failure of the life support device or system, or to affect its safety or effectiveness.

BANNED SUBSTANCE COMPLIANCE

National Semiconductor certifies that the products and packing materials meet the provisions of the Customer Products Stewardship Specification (CSP-9-111C2) and the Banned Substances and Materials of Interest Specification (CSP-9-111S2) and contain no "Banned Substances" as defined in CSP-9-111S2.



National Semiconductor
Americas Customer
Support Center
 Email: new.feedback@nsc.com
 Tel: 1-800-272-9959

National Semiconductor
Europe Customer Support Center
 Fax: +49 (0) 180-530 85 86
 Email: europe.support@nsc.com
 Deutsch Tel: +49 (0) 69 9508 6208
 English Tel: +44 (0) 870 24 0 2171
 Français Tel: +33 (0) 1 41 91 8790

National Semiconductor
Asia Pacific Customer
Support Center
 Email: ap.support@nsc.com

National Semiconductor
Japan Customer Support Center
 Fax: 81-3-5639-7507
 Email: jpn.feedback@nsc.com
 Tel: 81-3-5639-7560